

DATASHEET













FlexiBowl[®] 350 C/CC

Flexible feeding system for all parts measuring between **1** and **20 mm** and weighing up to **40 g**

FlexiBowl[®] 350C/CC can feed products of any geometry, surface and material. It is compatible with all industrial robots and vision systems. One FlexiBowl[®] can feed entire ranges of parts measuring 1 to 20 mm and weighing up to 40 g, replacing the need for the numerous units used in conventional systems.



ADVANTAGES

-  High performance
-  Compatible with 99.9% of parts
-  Essential design, robust construction
-  Specifically engineered for small parts
-  Remote-controlled electronics for dirty environments
-  Rapid, intuitive integration
-  Several singulation options
-  Accurate location of parts
-  Adatto a componenti delicati
-  Large area for singulation and picking
-  Low maintenance
-  Patented

HOW IT WORKS

Parts dropping, singulation and picking take place simultaneously in dedicated sectors. For greater productivity.

NOTE: The edge on FlexiBowl[®] 350 C/CC transitions smoothly from the main body to avoid parts getting stuck around the ring or under the surface.

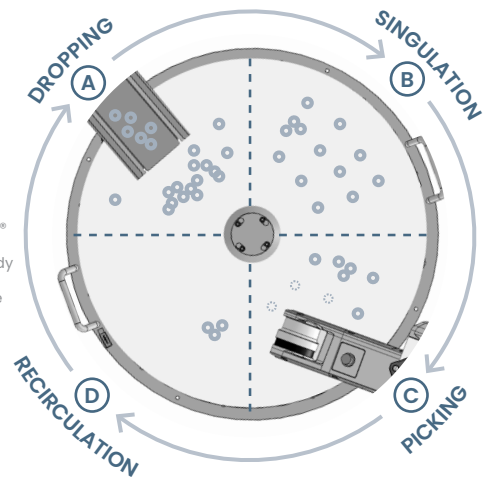

OPERATING MODES

 **Traditional**

Parts are singulated by the combined action of bidirectional rotation and the pulse generator. Once the parts are separated, the robot uses the coordinates sent by the vision system to locate and pick them up, while the disc is not moving.



PRECISION	■■■■■	LAYOUT	■■■□□
PERFORMANCE	■■■■■	EASY TO INTEGRATE	■■■■■
SINGULATION	■■■■■		

DATASHEET

FlexiBowl® 350 C/CC

Flexible feeding system for all parts measuring between **1** and **20 mm** and weighing up to **40 g**

SPECIFICATIONS

Dimensions of parts	1<x<20 mm
Weight of parts	<40 g
Backlit area	166 cm ²
Load capacity	3 kg
Bulk feeder/hopper load capacity	5/10 dm ³
Overall dimensions	447 mm
Picking height	270 mm
Installation temperature	5-45 °C
Installation position	Floor
Air pressure (dry and filtered)	6 bar - Ø 6 mm pipe
Electronic power supply	110-230 VAC
Red backlight wavelength	630 nm
Infrared backlight wavelength	850 nm
Absorption	150 W
Data connection	<ul style="list-style-type: none"> - Ethernet IP - Digital I/O - TCP/IP-UDP - Gateway for other protocols

DIMENSIONS

A	328 mm	G	299,5 mm
B	357 mm	H	328 mm
C	10 mm	I	447 mm
D	31,5 mm	L	78,5 mm
W	380 mm	M	230 mm
F	404 mm	Weight	25 kg

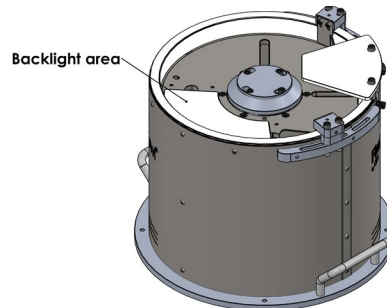
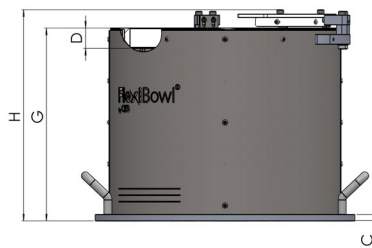
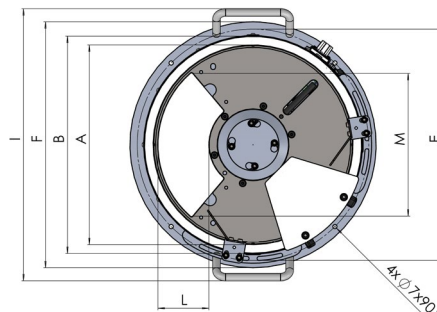

OPTIONAL ACCESSORIES

- ▶ Analog Electro Pneumatic Regulator
- ▶ Calibration Plate
- ▶ Camera Bracket Base Stand
- ▶ Custom grooved Discs
- ▶ Diverters
- ▶ External Swivel Gripper
- ▶ Lighting (white, red, IR)
- ▶ Remote Control Box
- ▶ Rotary Discs (including FDA-compatible and anti-static)

PLUG-INS

FlexiBowl is compatible with all TCP/IP socket languages and offers plug-ins for a vast range of robots, including:

- ▶ ABB
- ▶ Denso
- ▶ Doosan
- ▶ Epson
- ▶ Fanuc
- ▶ Kawasaki
- ▶ Kuka
- ▶ Mecademic
- ▶ Mitsubishi Electric
- ▶ Omron
- ▶ Staubli
- ▶ Techman Robot
- ▶ Universal Robots

PLC PLUG-INS AVAILABLE:

- ▶ Allen – Bradley
- ▶ Omron
- ▶ Siemens

ROTARY DISC TYPES

Including FDA-compatible and anti-static

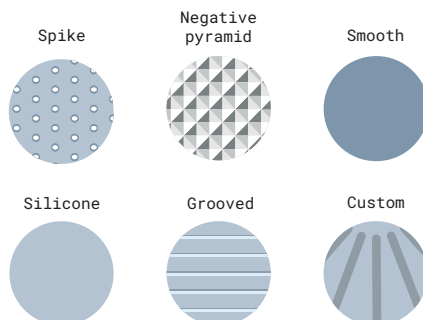

CONTACTS

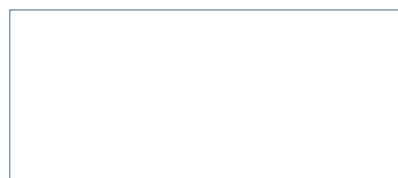

Ars s.r.l.
Via G. Vico, 7
52100 Arezzo
Tel: +39.0575.398611
P.I. 01739760518
sales@arsautomation.com
www.flexibowl.com

